

SS-42D02

Rating : 0.3A 50V DC

Function: 4P2T

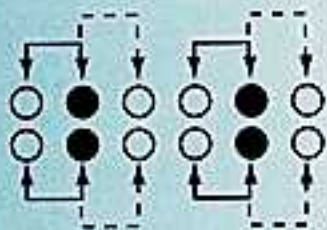

Optional knob type

VAC	PGB	GEE			

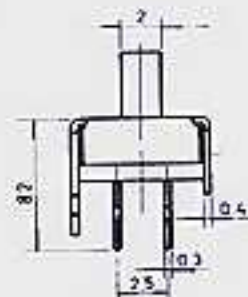
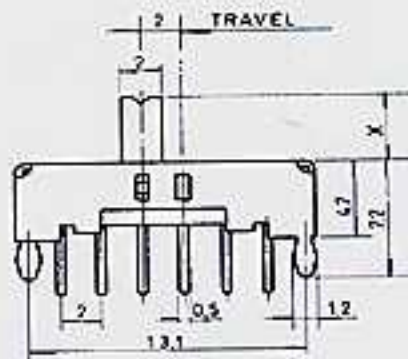
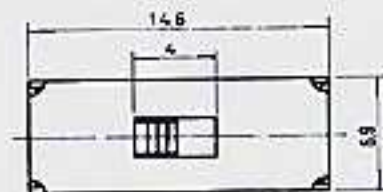
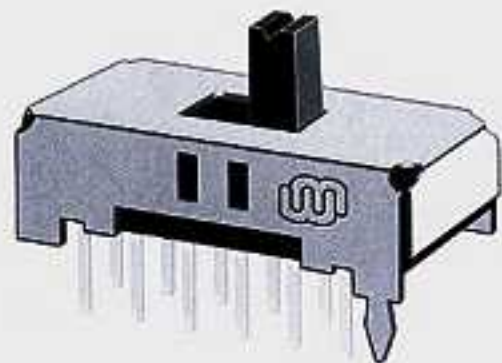

SS-42L01

Rating : 0.3A 50V DC

Function: 4P2T

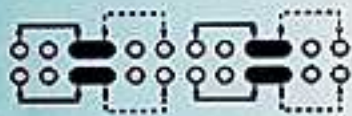

Optional knob type

GDL	GDD	MXF	ATA	NYA	

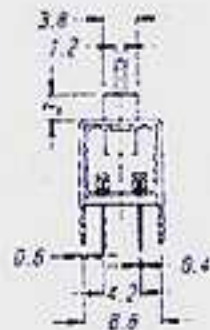
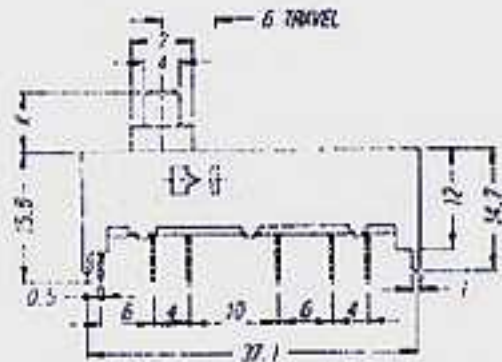
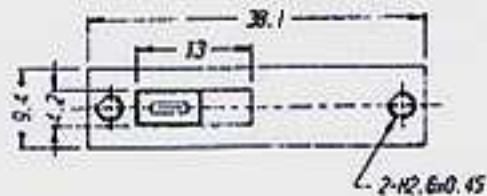
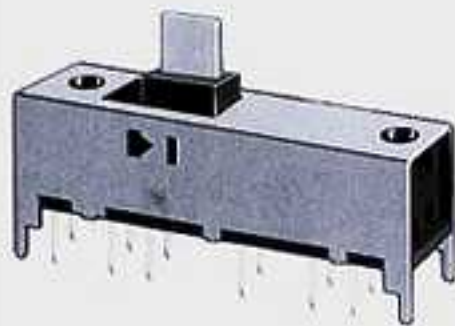

SS-42H38

Rating : 0.3A 50V DC

Function: 4P2T



Optional knob type

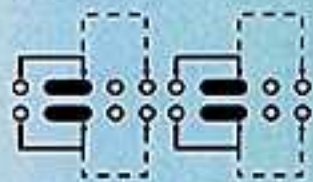

GAK	GDB	GDD	GES	TAT	MXF
TAI	GER	ATA	NYA		

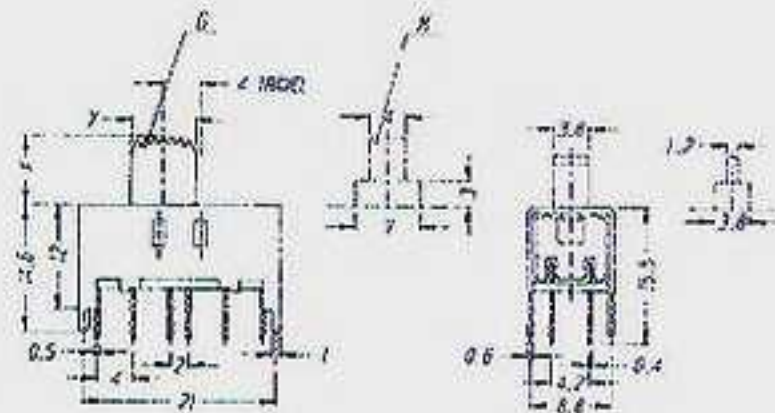
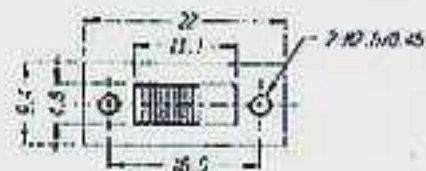
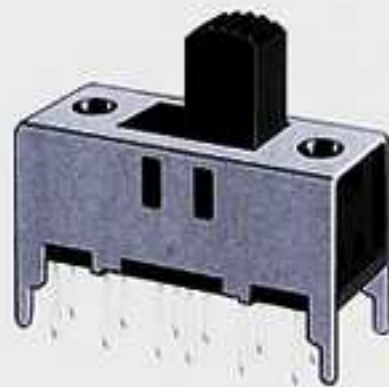

SS-42H28

Rating : 0.3A 50V DC

Function: 4P2T

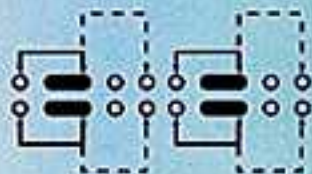

Optional knob type

GAK	GDB	GDD	GES	TAT	MXF
TAI	GER	ATA	NYA		

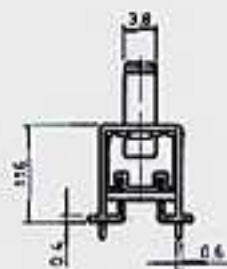
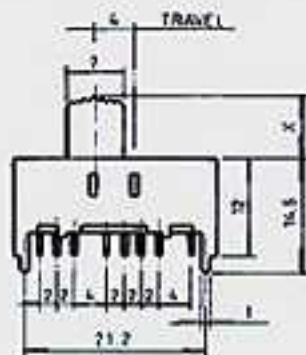
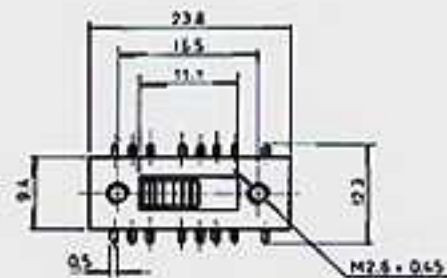
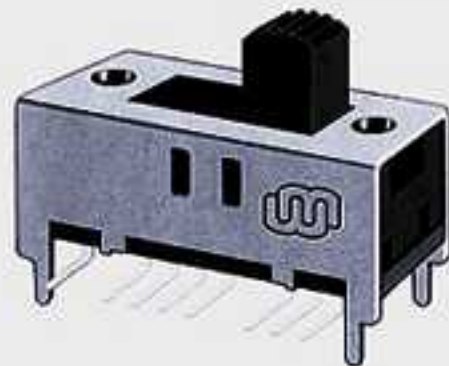

SS-42H24

Rating : 0.3A 50V DC

Function: 4P2T

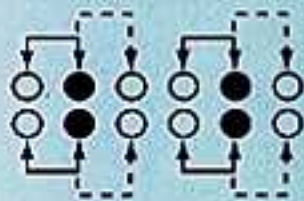

Optional knob type

MXF	GDD	ATA	NYA		

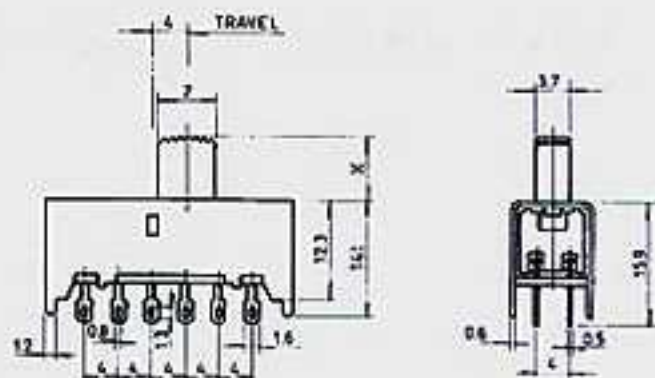
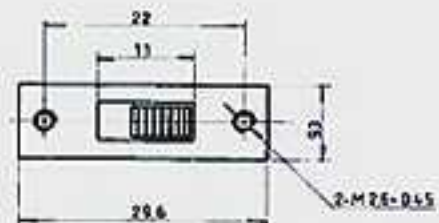
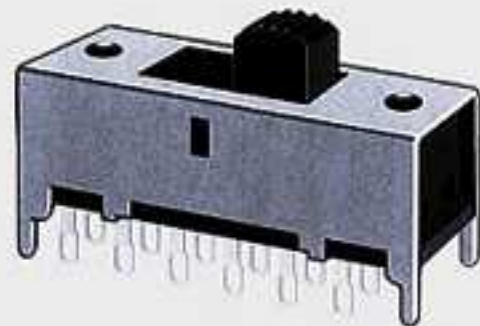

SS-42H23

Rating : 0.5A 50V DC

Function: 4P2T

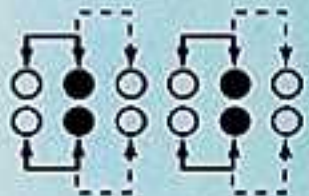

N

Optional knob type

MXF	GDD	ATA	NYA		

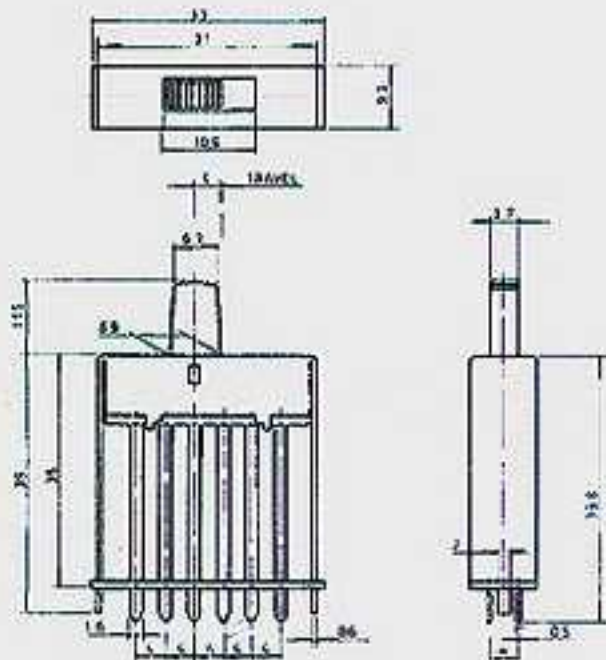

SS-42H18

Rating : 0.3A 50V DC

Function: 4P2T

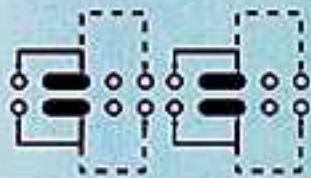

Optional knob type

GAK	GDB	GDD	GES	TAT	MXF
TAI	GER	ATA	NYA		

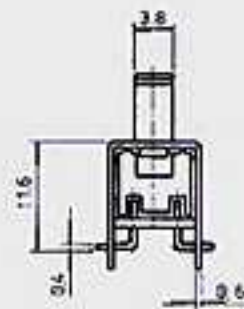
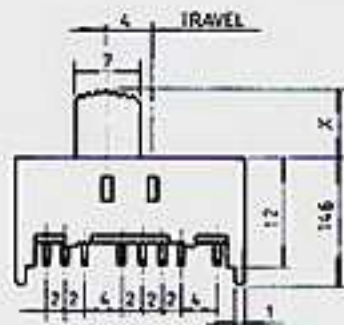
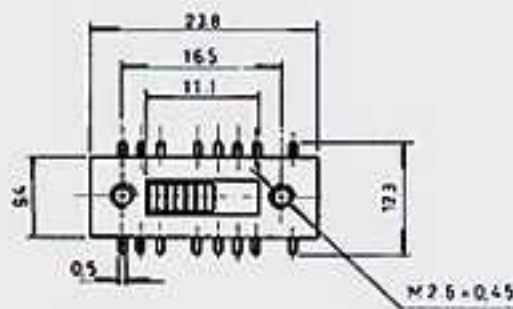
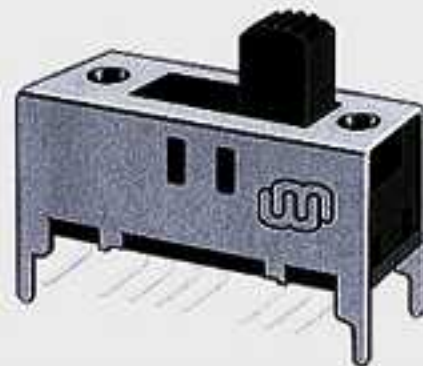

SS-42H14

Rating : 0.3A 50V DC

Function: 4P2T

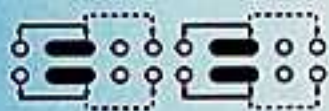

Optional knob type

GBC					

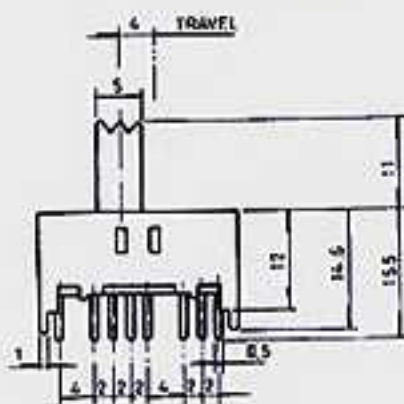
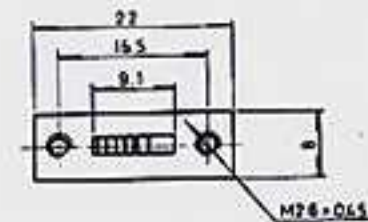

SS-42H11

Rating : 0.3A 50V DC
Function: 4P2T

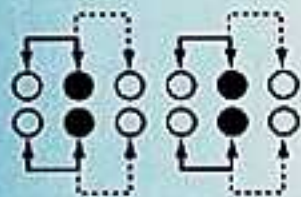

Optional knob type

GAK	GDB	GDD	GES	TAT	MXF
TAI	GER	ATA	NYA		

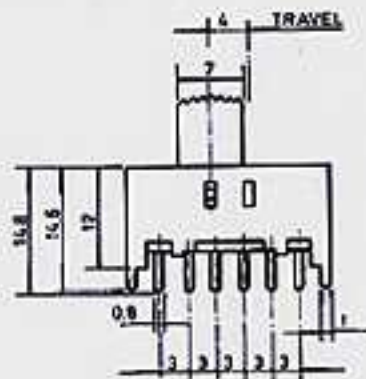
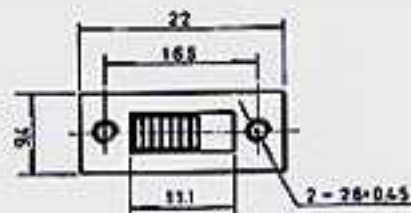
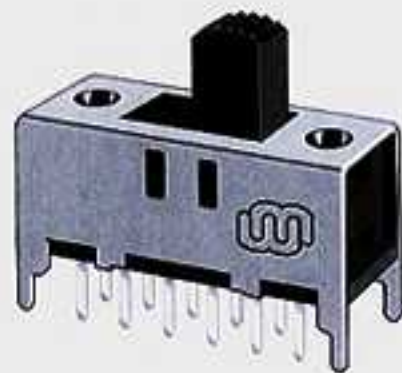

SS-42H10

Rating : 0.3A 50V DC

Function: 4P2T

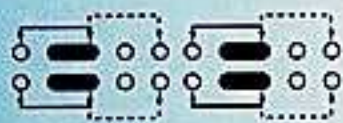
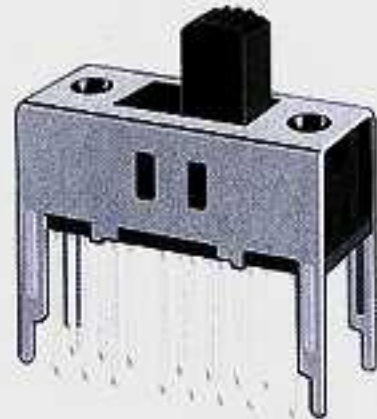

Optional knob type

GAK	GDB	GDD	GES	TAT	MXF
TAI	GER	ATA	NYA		

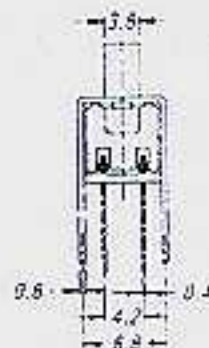
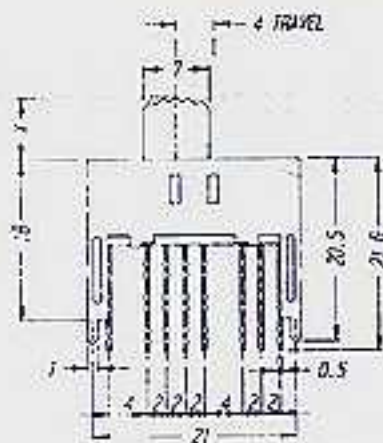
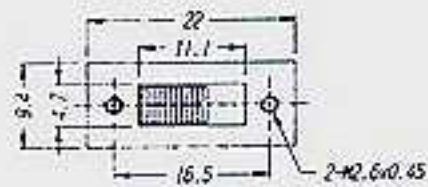

SS-42H09

Rating : 0.3A 50V DC

Function: 4P2T

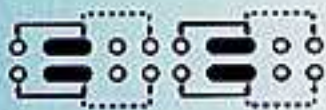

Optional knob type

GAK	GDB	GDD	GES	TAT	MXF
TAI	GER	ATA	NYA		

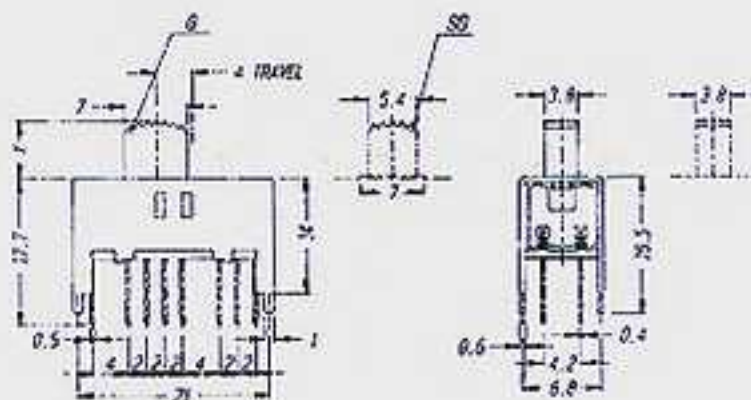
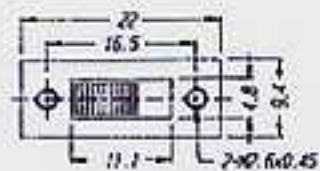
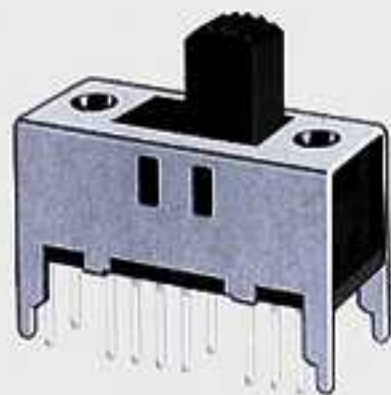

SS-42H08

Rating : 0.3A 50V DC

Function: 4P2T

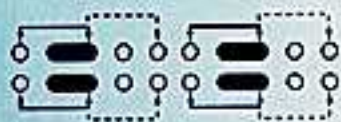

Optional knob type

GAK	GDB	GDD	GES	TAT	MXF
TAI	GER	ATA	NYA		

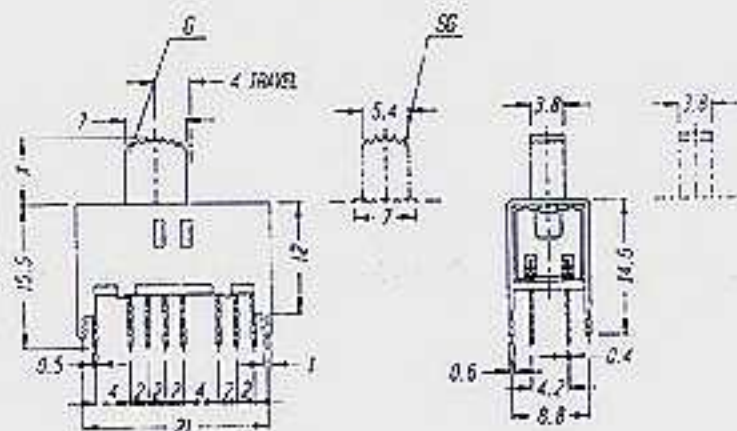
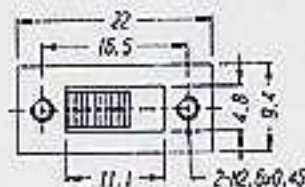
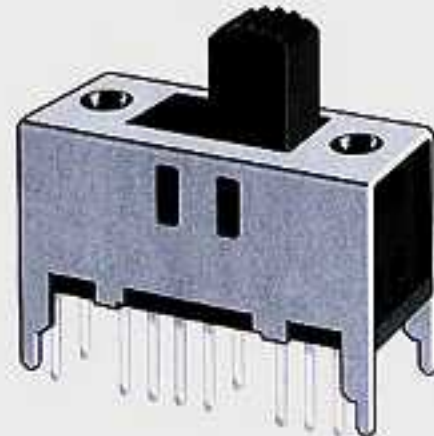

SS-42H07

Rating : 0.3A 50V DC

Function: 4P2T

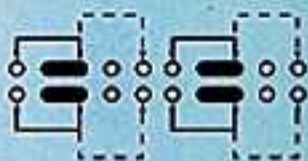

Optional knob type

GAK	GDB	GDD	GES	TAT	MXF
TAI	GER	ATA	NYA		

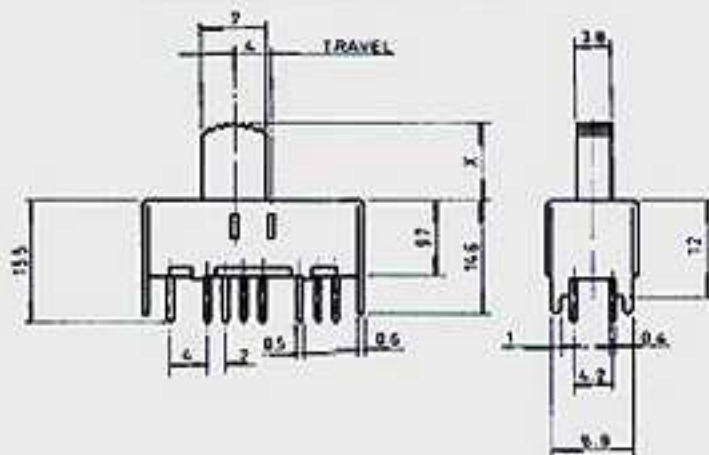
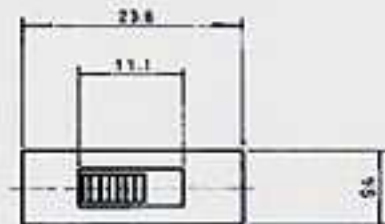
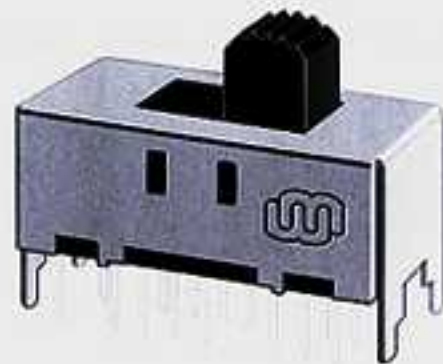

SS-42H04

Rating : 0.3A 50V DC

Function: 4P2T

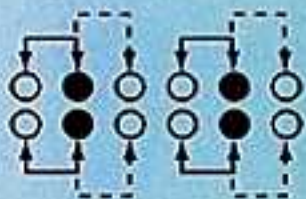

Optional knob type

GDD	ATA	NYA			

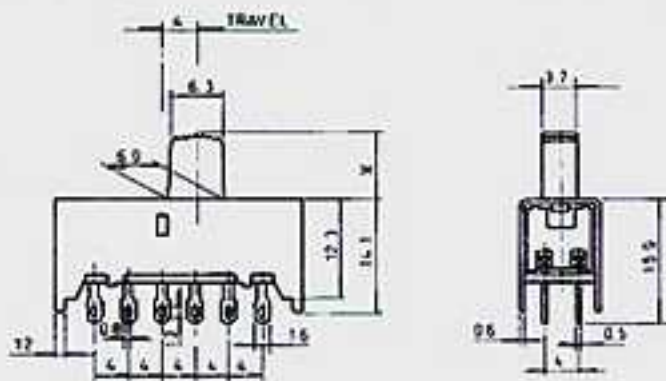
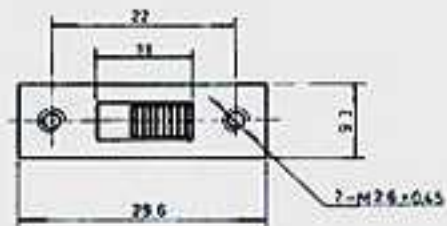
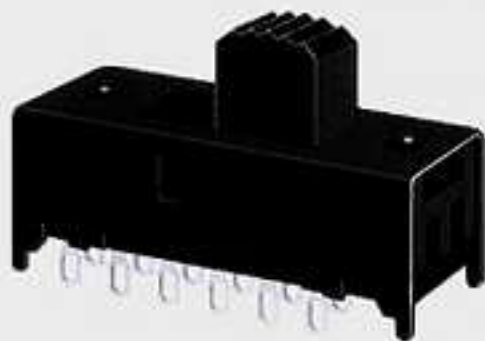

SS-42H03

Rating : 0.3A 50V DC

Function: 4P2T

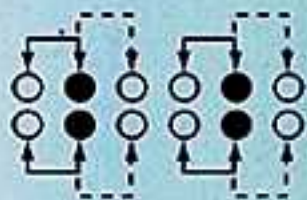

Optional knob type

GDD	ATA	NYA			

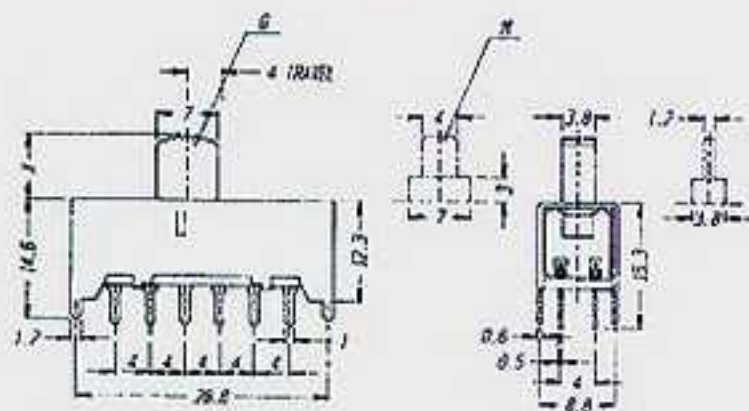
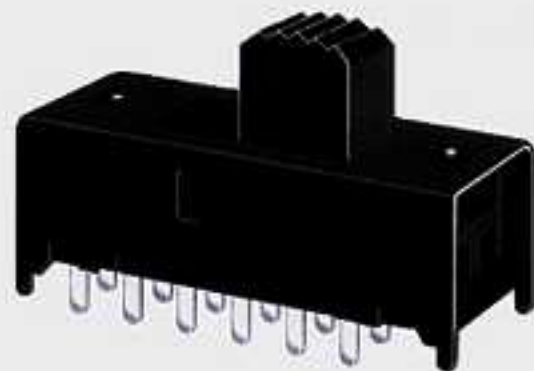

SS-42H01

Rating : 0.3A 50V DC

Function: 4P2T

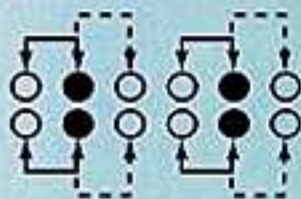

Optional knob type

MXF	GDD	ATA	NYA		

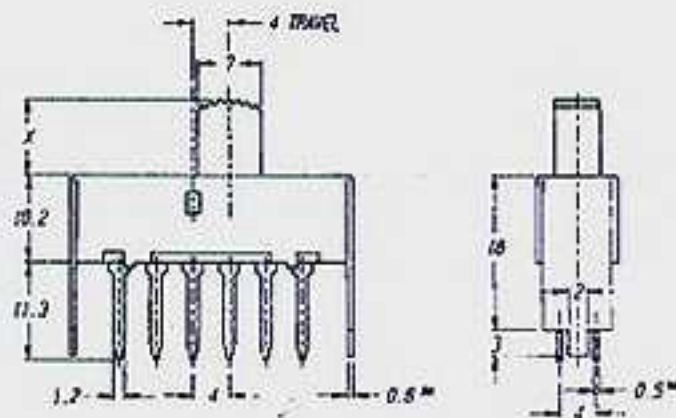
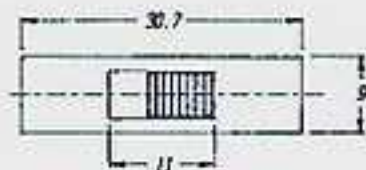
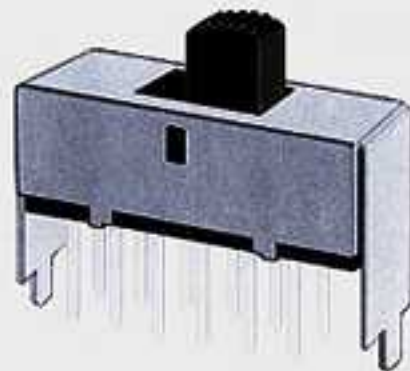

SS-42F01

Rating : 0.3A 50V DC

Function: 4P2T

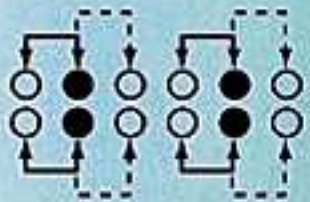

Optional knob type

GDE	GDI	MXD	ATA	NYA	

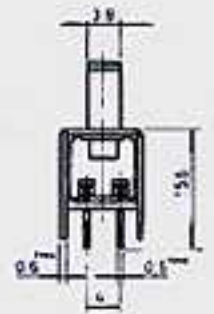
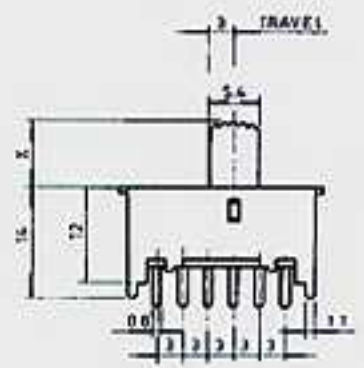
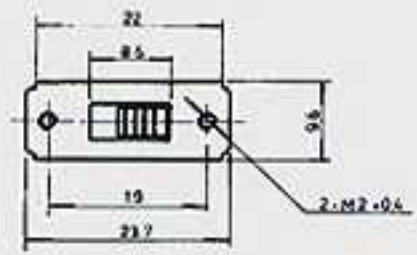
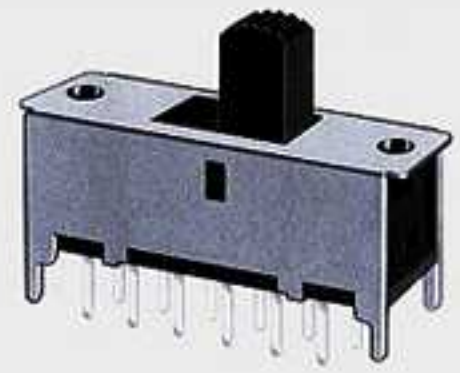

SS-42D24

Rating : 0.3A 50V DC

Function: 4P2T

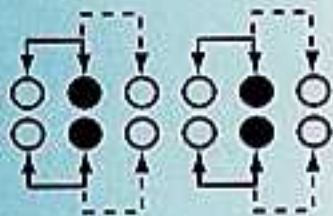

Optional knob type

GDE	GDI	MXD	ATA	NYA	

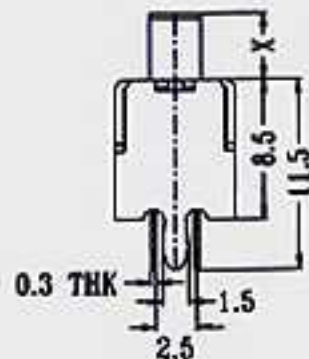
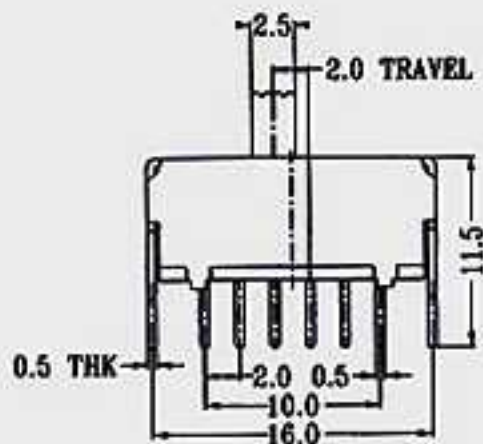
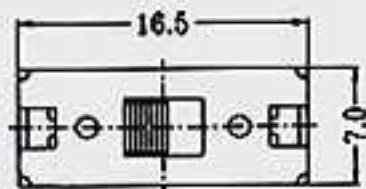
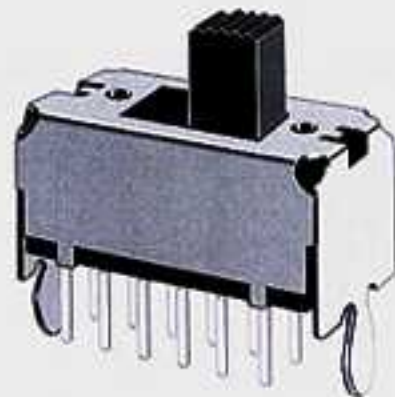

SS-42D04

Rating : 0.3A 50V DC

Function: 4P2T

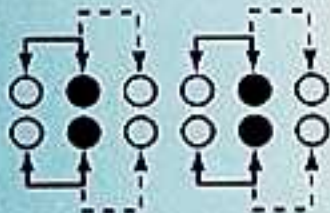
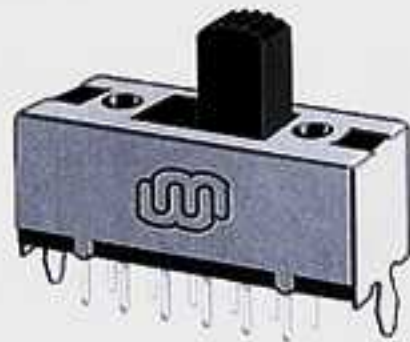

Optional knob type

GBC					

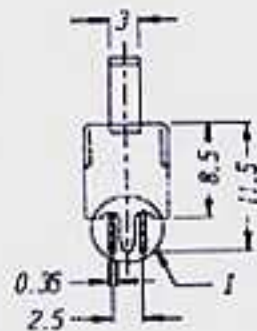
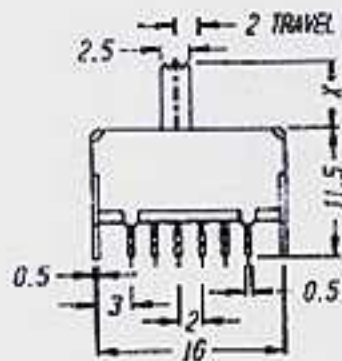
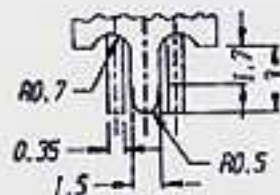
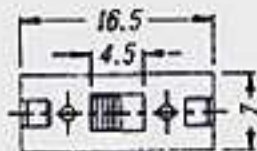

SS-42L02

Rating : 0.3A 50V DC

Function: 4P2T

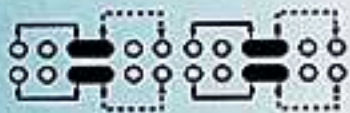

Optional knob type

GDD	MXF	ATA	NYA		

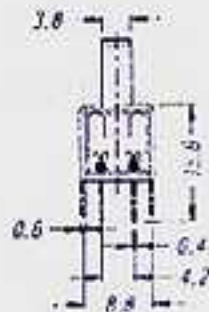
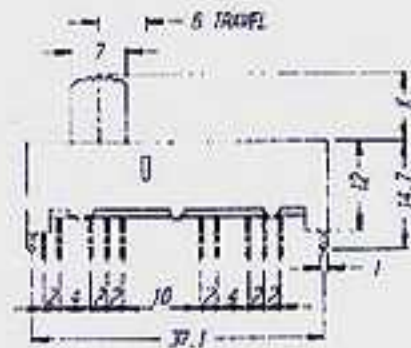
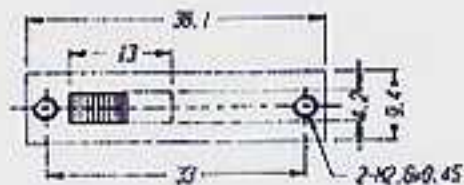
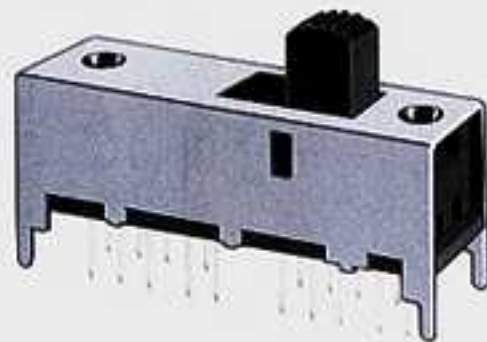

SS-43D31

Rating : 0.3A 50V DC

Function: 4P3T

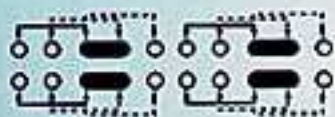

Optional knob type

TAI	GER	GDD	MXF	ATA	NYA

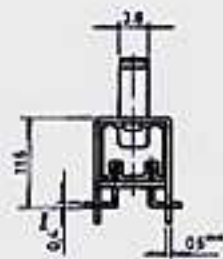
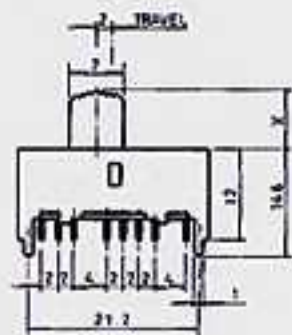
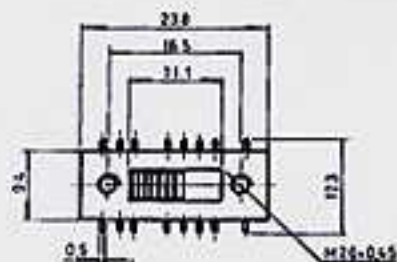
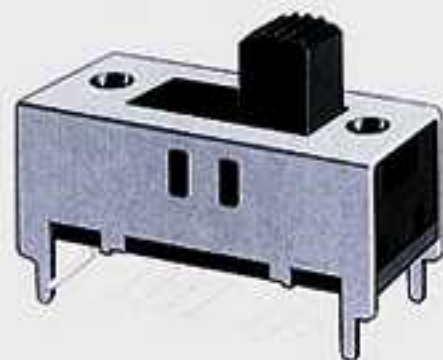

SS-43D21

Rating : 0.3A 50V DC

Function: 4P3T



Optional knob type

TAI	GER	GDD	MXF	ATA	NYA

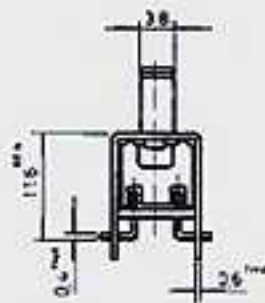
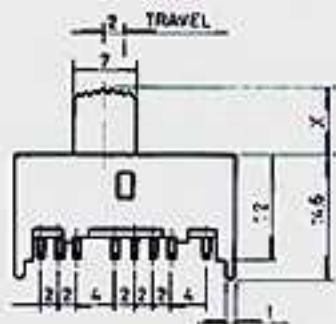
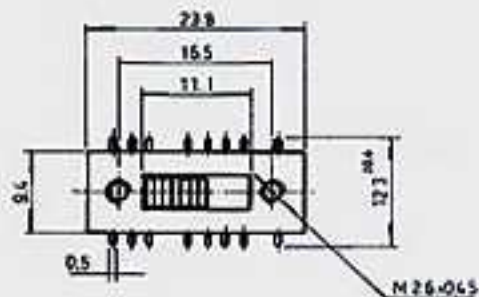
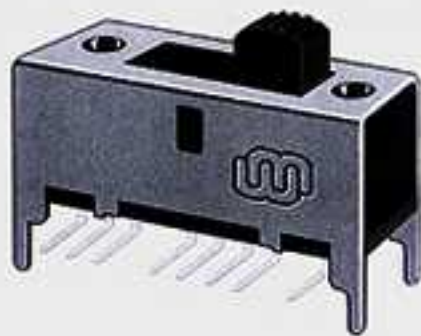

SS-43D13

Rating : 0.3A 50V DC

Function: 4P3T



Optional knob type

GEC	ATA	NYA			

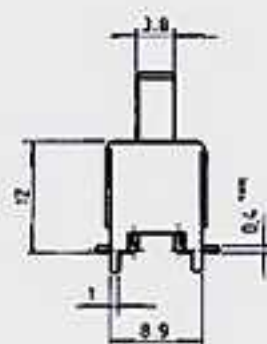
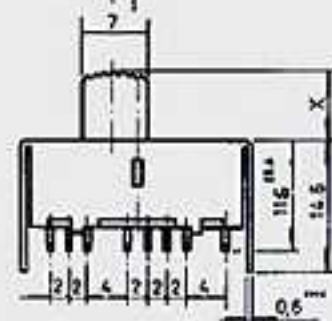
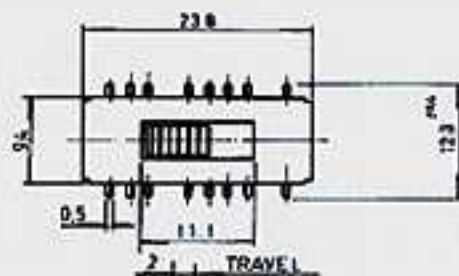
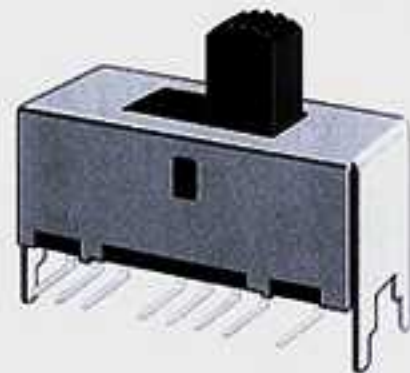

SS-43D11

Rating : 0.3A 50V DC

Function: 4P3T



Optional knob type

GEC					

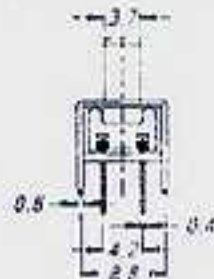
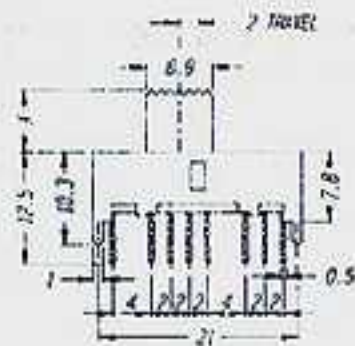

SS-43D10

Rating : 0.3A 50V DC

Function: 4P3T



Optional knob type

TAI	GER	GDD	MXF	ATA	NYA

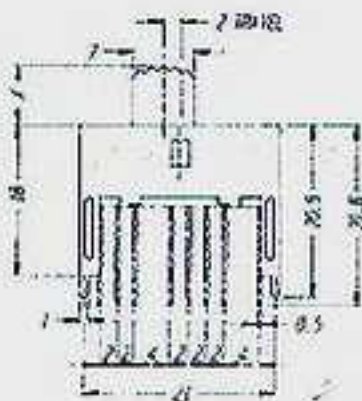
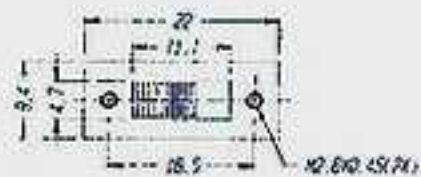

SS-43D04

Rating : 0.3A 50V DC

Function: 4P3T



Optional knob type

GEL					

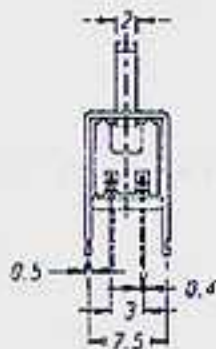
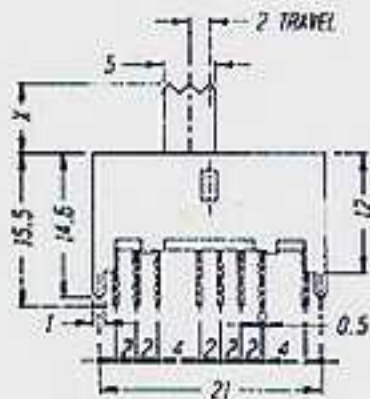
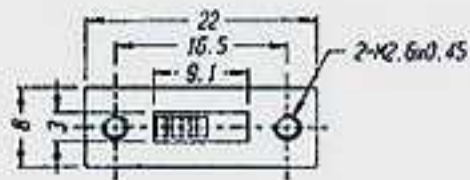

SS-43D03

Rating : 0.3A 50V DC

Function: 4P3T

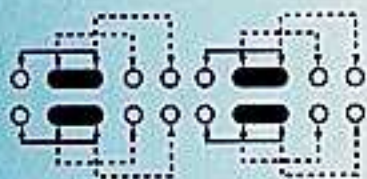

Optional knob type

TAI	GER	GDD	MXF	ATA	NYA

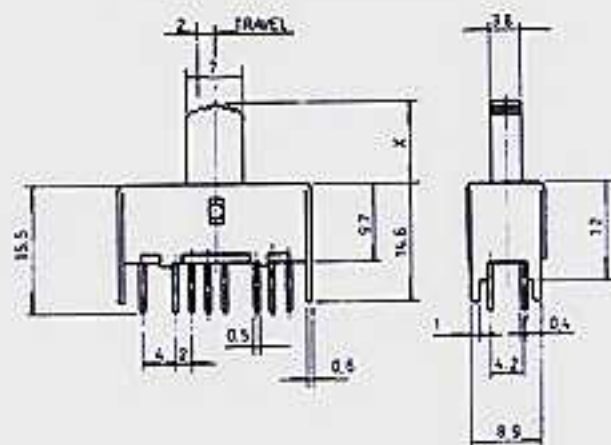
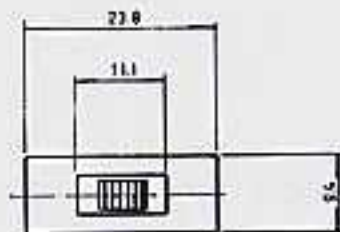
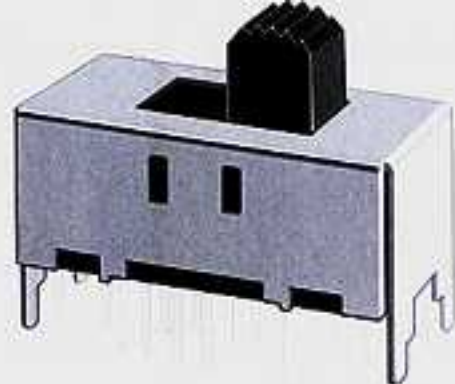

SS-43D02

Rating : 0.3A 50V DC

Function: 4P3T

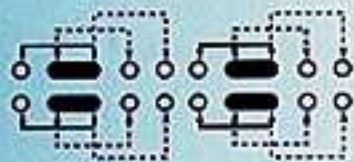

Optional knob type

GAK	GDB	GDD	GES	TAT	MXF
TAI	GER	ATA	NYA		

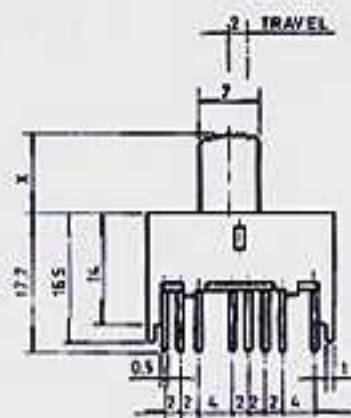
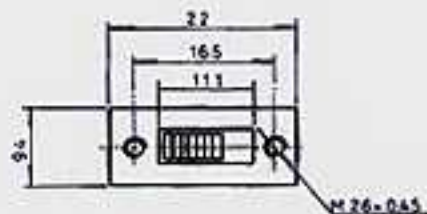

SS-43D01

Rating : 0.3A 50V DC

Function: 4P3T

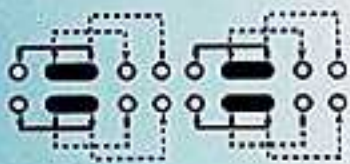

Optional knob type

GAK	GDB	GDD	GES	TAT	MXF
TAI	GER	ATA	NYA		

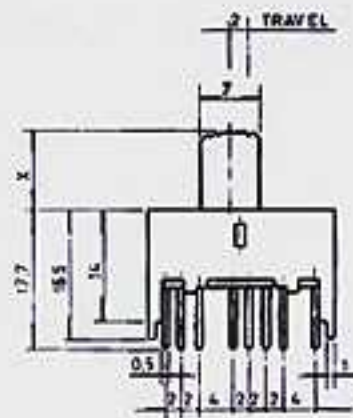
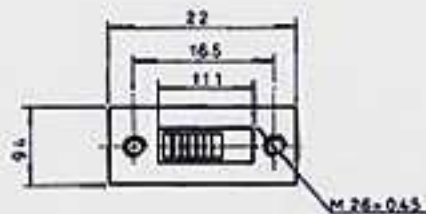
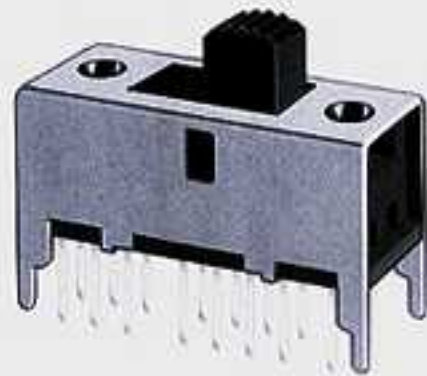

SS-44D05

Rating : 0.3A 50V DC

Function: 4P4T

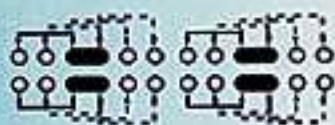

Optional knob type

GER	GDD	TAI	MXF	GEE	GDR
GER	GES				

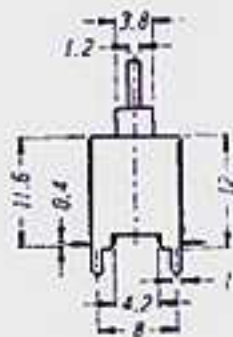
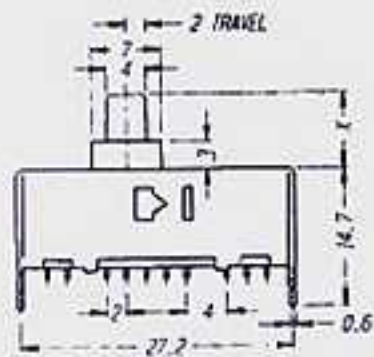
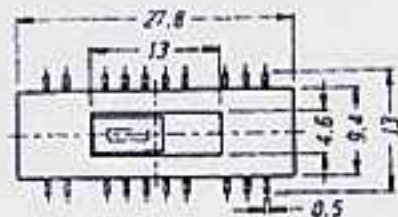

SS-44D04

Rating : 0.3A 50V DC

Function: 4P4T

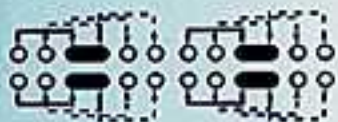

Optional knob type

GER	GDD	TAI	MXF	GEE	GDR
GER	GES				

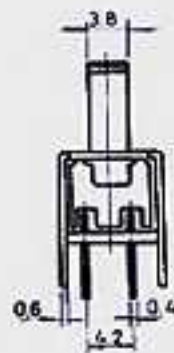
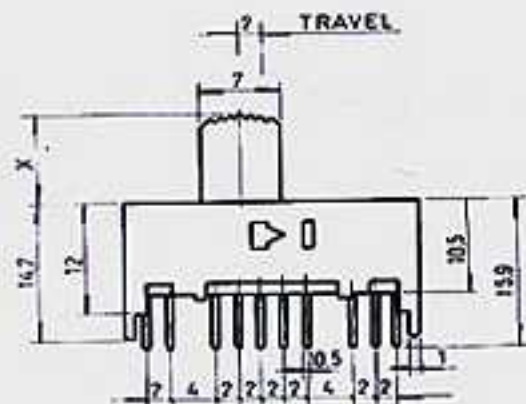
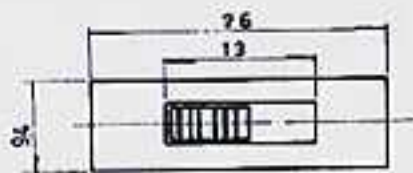
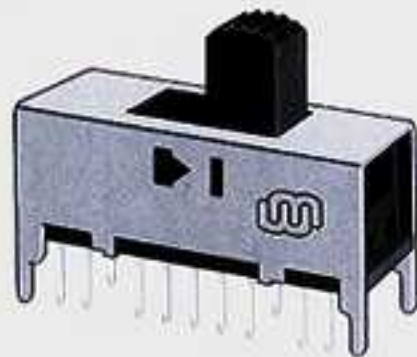

SS-44D03

Rating : 0.3A 50V DC

Function: 4P4T

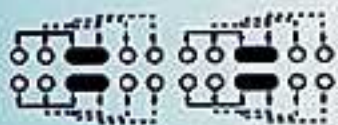

Optional knob type

GER	GDD	TAI	MXF	GEE	GDR
GER	GES				

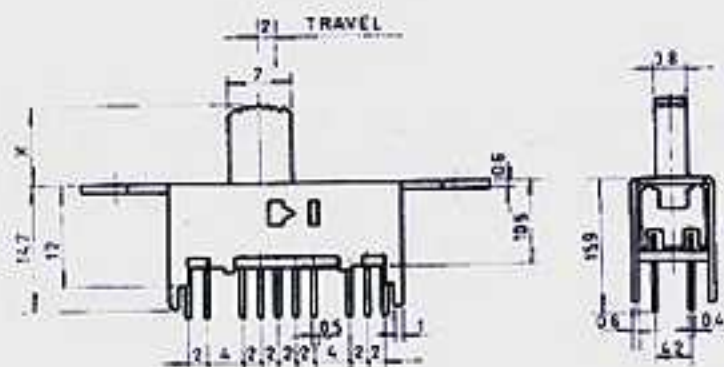
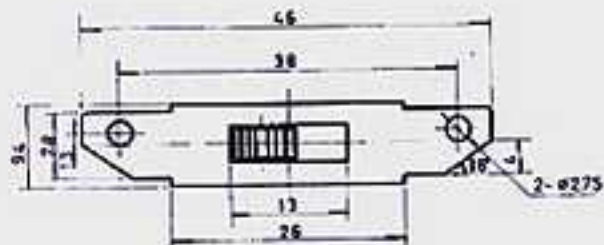
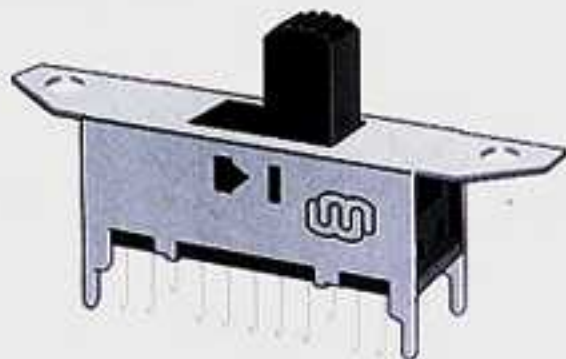

SS-44D02

Rating : 0.3A 50V DC

Function: 4P4T

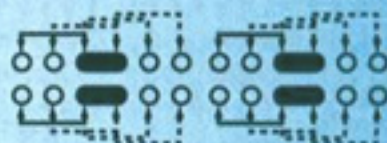

Optional knob type

TAI	GER	GDD	MXF	ATA	NYA

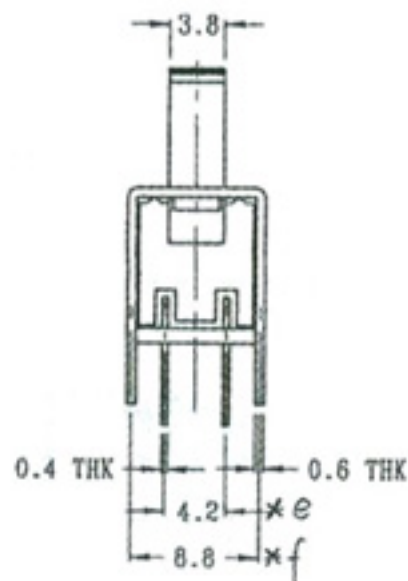
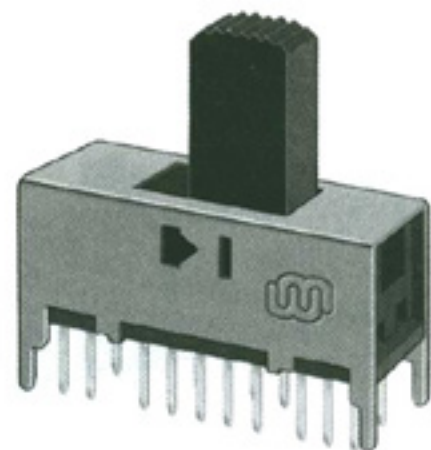
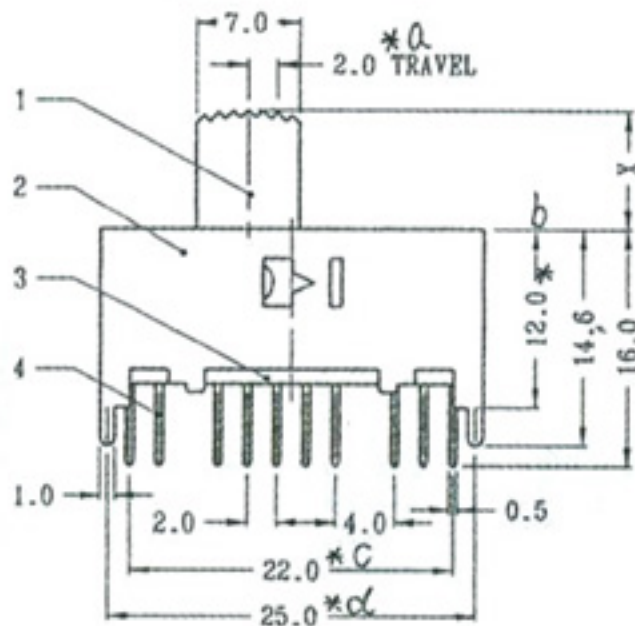
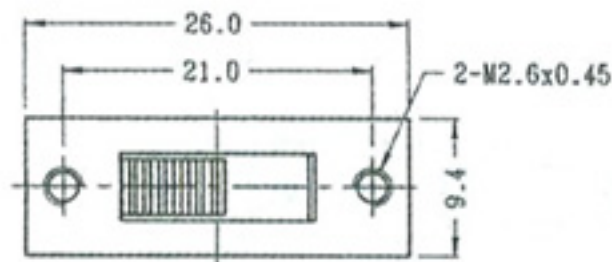

SS-45P01

Rating : 0.5A 50V DC

Function: 4P5T

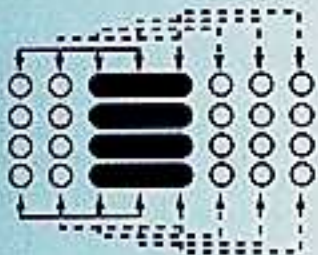

Optional knob type

MXE					

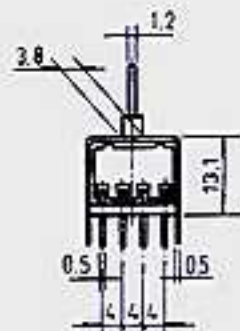
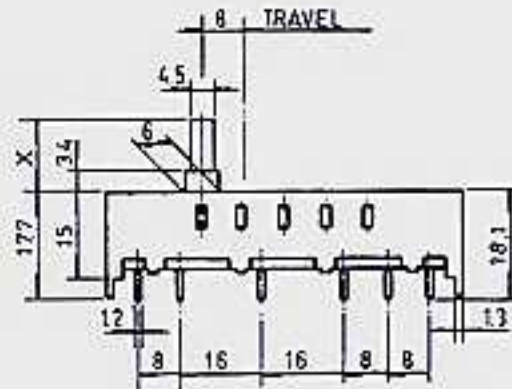
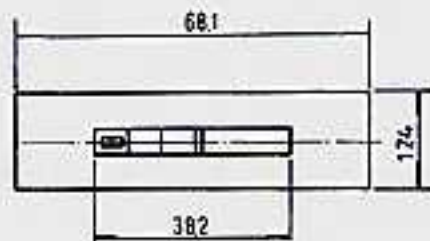
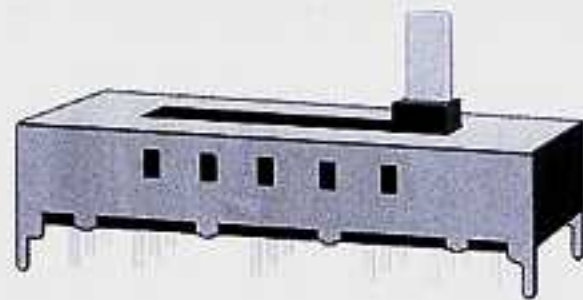

SS-47D01

Rating : 0.3A 50V DC

Function: 4P7T

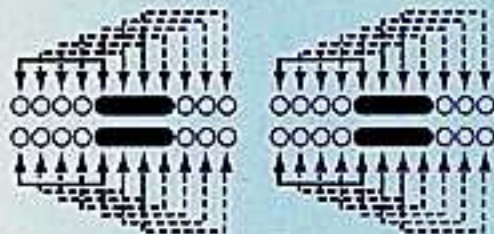

Optional knob type

GBK					

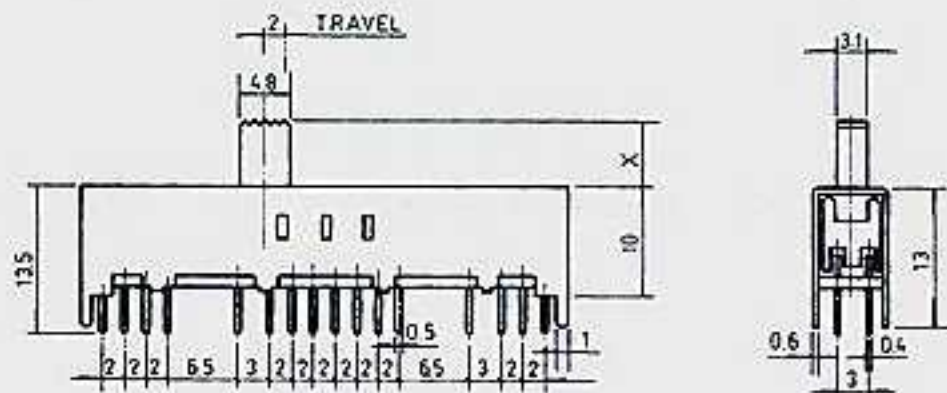
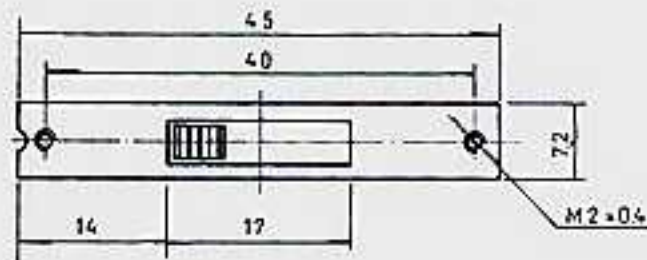
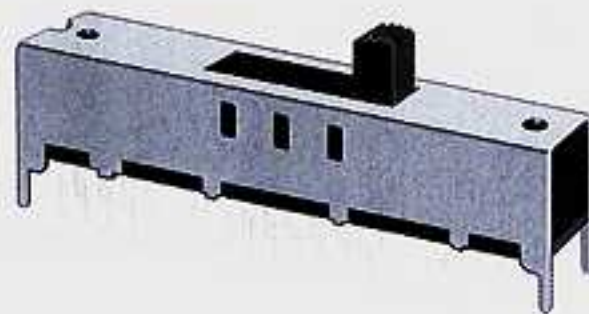

SS-48D01

Rating : 0.3A 50V DC

Function: 4P8T

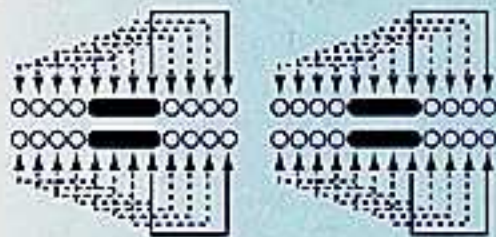

Optional knob type

GBK					

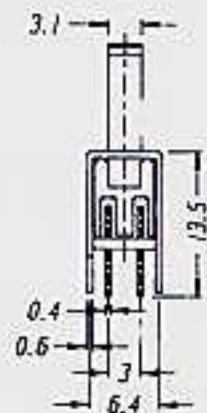
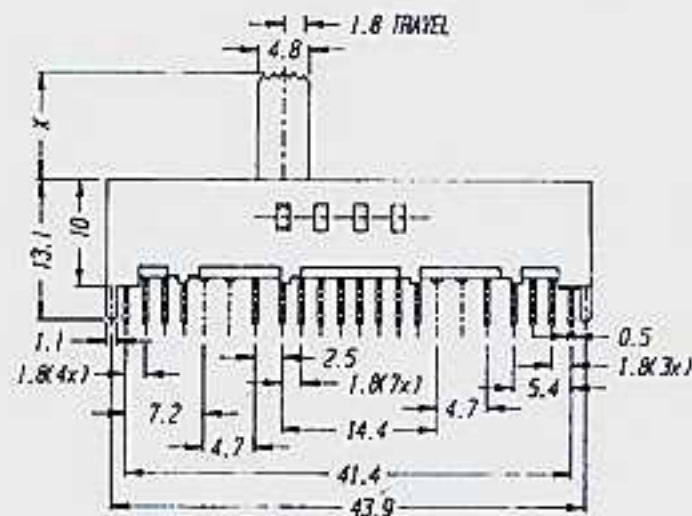
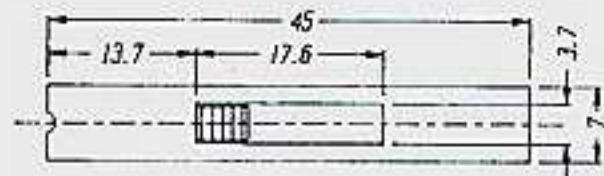
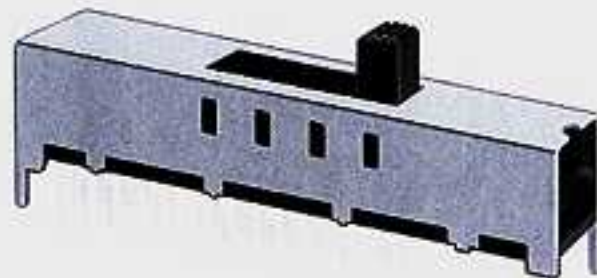

SS-49D01

Rating : 0.3A 50V DC

Function: 4P9T



Optional knob type

GBK					

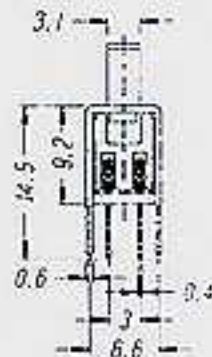
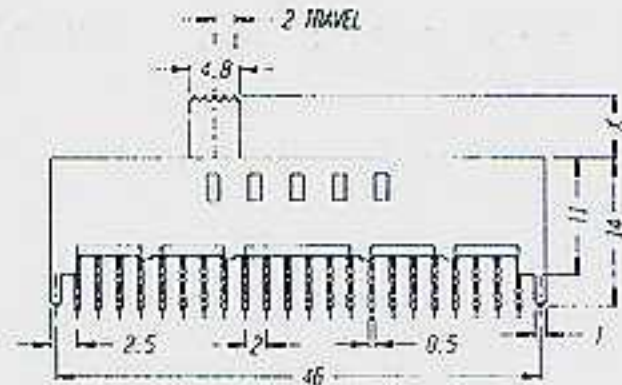
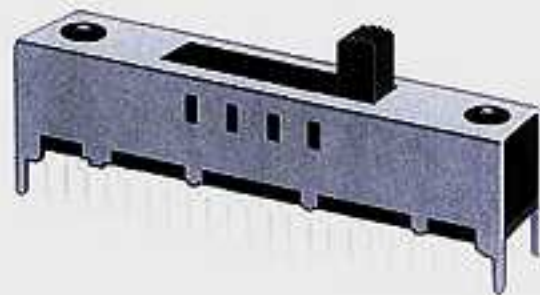
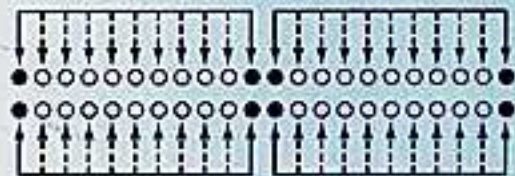

SS-412D01

Rating : 0.3A 50V DC

Function: 4P12T

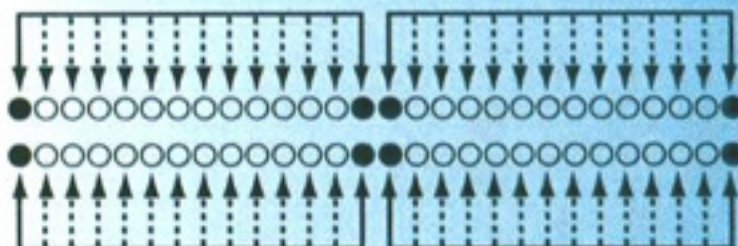

Optional knob type

TAX	TAM				

